



Technical Guide January 2014. GSW 40-L.

car **Teck**

Sectional Garage Doors
Side Hinged Garage Doors
Super Size Garage Doors

With security, design and comfort



Installation data

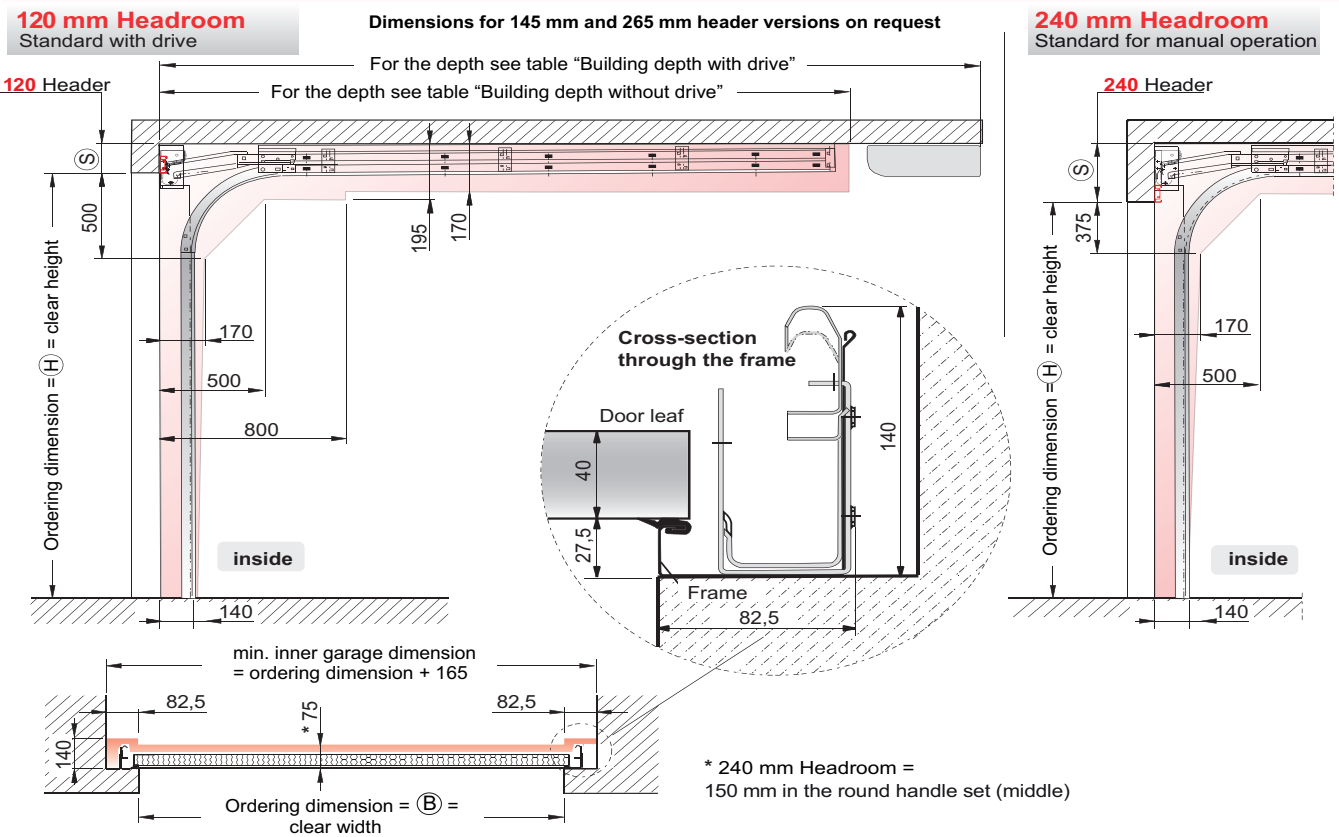

Please observe the following measurement details to guarantee exact assembly and precise and reliable operation of the CarTeck sectional door.

- (B) clear opening width (= ordering dimension)
 - (H) clear height (= ordering dimension)
- The clearance height corresponds to the distance from the upper edge of the floor to the lower edge of the header. When planning, please consider the distance will be reduced due to the application of screed or asphalt.

(S) The required headroom increases by + 25 mm for doors with reinforced roller retainers

	Required headroom: (S)	Clear opening height:	
with drive	120 mm	completely free	Standard version
Manual operation	240 mm	- 25 mm	Standard version
Manual operation	120 mm	- 150 mm	Special version
Manual operation	120 mm	- 80 mm	Special version with door stopper (see accessories GSW doors)
with drive	240 mm	completely free	Special version with pack – 125 mm extended top roller retainers (see accessories GSW doors)

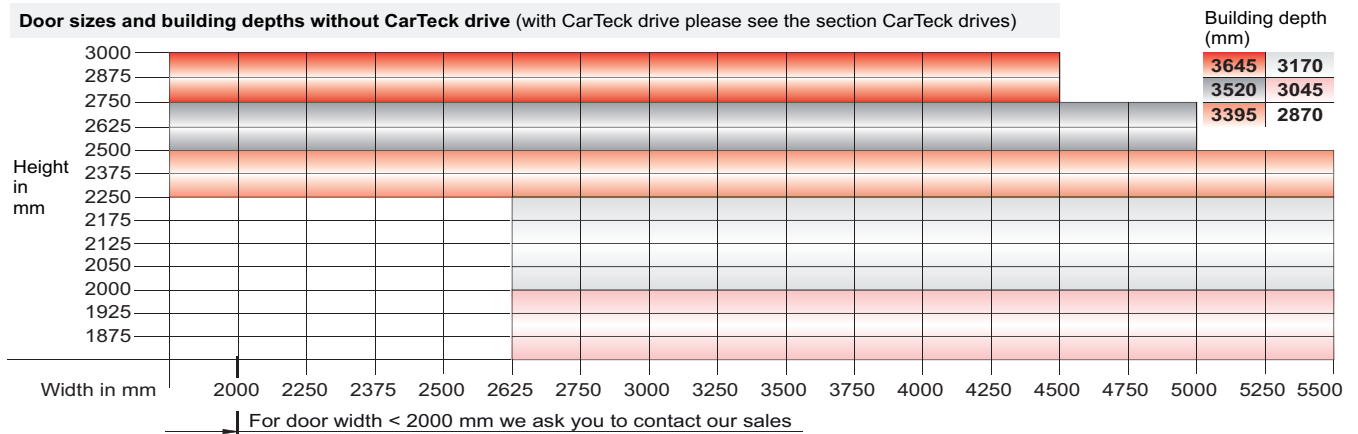

carTeck® Sectional Door

GSW 40-S, GSW 40-M and GSW 40-L



Double-skinned steel slats 40 mm

Product description

Versions: The drawings represent a 2500 x 2125 mm garage door

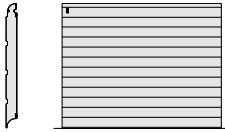

Ribbed

evenly arranged horizontal ribs of the door leaf

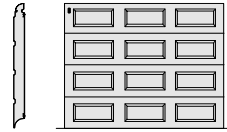

with cassette

evenly arranged panels across the whole width of the door

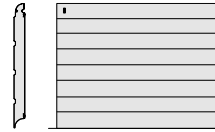

Centre Ribbed

evenly arranged horizontal ribs of the door leaf

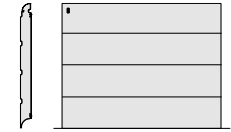

Unribbed



Tested burglar resistance:

All GSW 40-S, GSW 40-M and GSW 40-L CarTeck sectional doors with CarTeck drive satisfy the TÜV-tested TTZ guidelines "Burglar resistance for garage doors".

This applies to all doors with a locked door leaf (without glazing and without a wicket door)

5 Point Guarantee



5-year manufacturer's guarantee

on rollers, hinges, springs*, cable drums and cables under normal use of max. 5 openings/closings per day.

*10-year manufacturer's guarantee with High-performance springs (see accessoires)

10-year manufacturer's guarantee

on the panel against rusting from the inside

10-year manufacturer's guarantee

on the steel splitting away from the foam

10-year manufacturer's guarantee

on the material and manufacturing faults of all immovable frame parts which are proven to be inoperative or seriously impaired on floor seal, central seals, side seals and header seal against perishing.

10-year manufacturer's guarantee

Please notify us immediately in writing if faults occur; the respective parts have to be sent to us on request.

Unfortunately, we shall not assume the costs for disassembly and assembly, freight or postage.

Standard version

• Garage sectional doors for domestic use

- With special connection console for rail-guided CarTeck drives

Door leaf GSW 40-S, GSW 40-M and GSW 40-L

- Door leaf consisting of individual, double-skinned door sections, including central seal with even arrangement, made of galvanized sheet steel 0.4 mm (GSW 40-S 0.3 mm panel outer surface)
- With finished surface, two layers on the outside (polyester-based 25 µm), one layer on the inside (polyester-based 10 µm)
- Building depth of the sections is 40 mm. Polyurethane foam core
- Finger pinch protection inside and outside in accordance with DIN EN 12604
- U-value: 0.56 W/m²k (slat 40 mm), 0.95 W/m²k (only door leaf), 1.48 W/m²k (complete door, door surface 10 m²)
- All CarTeck sectional doors are supplied with finished surface quality

Door leaf GSW 40-S

Surface inside: Stucco design

Standard colour inside: Galvanized with transparent protective film (similar to Sendzimir galvanized)

Surface outside: Woodgrain design

Standard colour outside: Finished surface traffic white, similar to RAL 9016

Door leaf GSW 40-M

Surface inside: Stucco design

Standard colour inside: Galvanized with transparent protective film (similar to Sendzimir galvanized)

Surface outside: Woodgrain design, stucco design

Standard colour outside: Finished surface traffic white, similar to RAL 9016

Door leaf GSW 40-L

Surface inside: Stucco design

Standard colour inside: Finished surface grey white, similar to RAL 9002

Surface outside: Woodgrain design, stucco design, smooth, micro-profiled

Standard colour outside: Finished surface traffic white, similar to RAL 9016

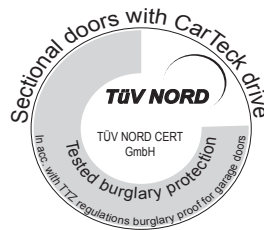

Product description

Avoid dark, as well metallic or micaceous iron ore colours or films for garage doors in direct sunlight, since cracks, warpage and malfunctioning cannot be excluded. Panels may expand, but will return to original shape as they cool.

CarTeck trend colours 2013 for GSW 40-M and GSW 40-L

CarTeck trend colours in coil coated design

Flame red	based on	RAL 3000	White aluminium	based on	RAL 9006
Moss green	based on	RAL 6005	Grey aluminium	based on	RAL 9007
Fir green	based on	RAL 6009			
Anthracite grey	based on	RAL 7016			
Light grey	based on	RAL 7035	trend colours with metallic effect		
Quartz grey	based on	RAL 7039	micaceous iron ore particles, not high gloss		
Window grey	based on	RAL 7040	Grey shades	TT 703 with micaceous iron ore particles	
Sepia brown	based on	RAL 8014	Brown shades	TT 8014 with micaceous iron ore particles	
Cream	based on	RAL 9001	Anthracite shades	TT 9011 with micaceous iron ore particles	
Jet black	based on	RAL 9005			

We reserve the right to change our trend colours from coil-coated design to painted design.

CarTeck wood designs 2013 for GSW 40-L

Film coating in UV resistant, thermoplastic surface film with wood design

- "Golden Oak"
- "Rosewood"
- "Dark Oak"
- "Winchester"

CarTeck RAL of your choice for GSW 40-M, GSW 40-L

CarTeck Colour of the steel sections similar to RAL colour chart

Therefore, always contact the sales department for the following colours:

Black red	based on	RAL 3007
Black blue	based on	RAL 5004
Black grey	based on	RAL 7021
Black brown	based on	RAL 8022
Signal black	based on	RAL 9004
Jet black	based on	RAL 9005
Graphite black	based on	RAL 9011
Traffic black	based on	RAL 9017

The following RAL colours are not supplied:

Traffic purple	based on	RAL 4006
Purple violet	based on	RAL 4007
Matt black	based on	RAL 9021
Grey aluminium	based on	RAL 9007

This also applies to all pearl, fluorescent and metallic colours.

Frame GSW 40-S

- Profile frame made of Sendzimir galvanized sheet steel, coil-coated with polyester finish surface traffic white similar to RAL 9016
- Seal casing with lip seal, at the side and at the header trim in EPDM quality
- 85 mm header trim default in traffic white similar to RAL 9016

Frame GSW 40-M and GSW 40-L

- Profile frame made of Sendzimir galvanized sheet steel, coil-coated with polyester finish surface traffic white similar to RAL 9016
- Optionally frame panelling in trend and RAL colours or films in wood design too at an additional charge
- Seal casing with lip seal, at the side and at the header trim in EPDM quality
- 85 mm header trim default in trend and RAL colours or films in wood design

Counterweight

- Via multiple tension spring / double cable system enclosed in a micro-profiled spring duct above the horizontal runner rail

Special version

- Default without manual locking mechanism. On request with manual locking mechanism (up to door width of 5000 mm)

Please refer to the CarTeck drives section for headrooms, recoil depths and descriptions.



1 Fixing points for frame

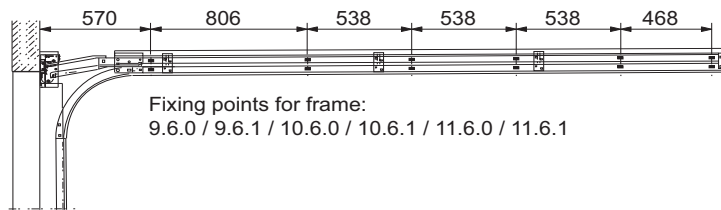
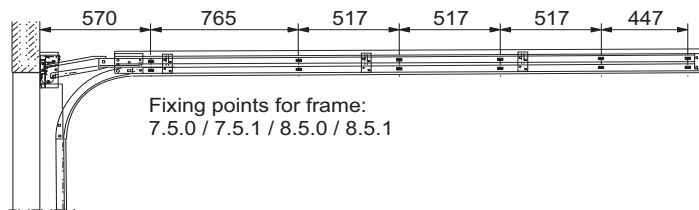
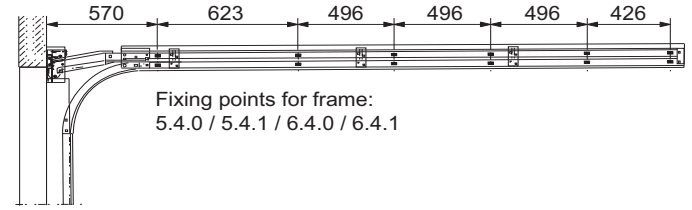
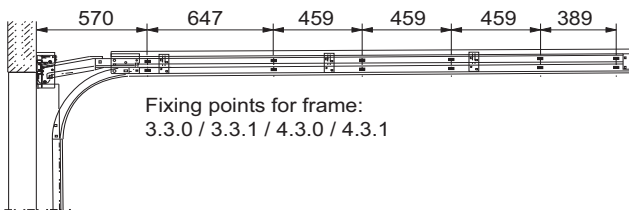
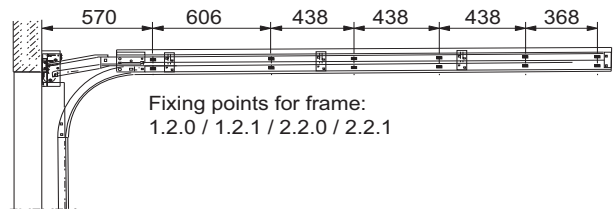
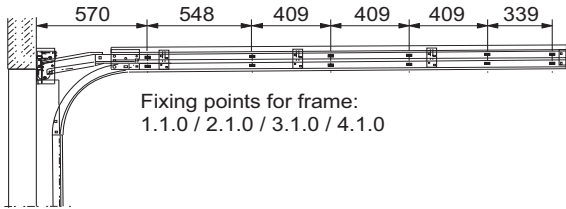

Height ↓	Frame component assignment												
3000 - 2876	10.6.0				10.6.1								
2875 - 2751	9.6.0				9.6.1	9.6.1	9.6.1	9.6.1	9.6.1	9.6.1	9.6.1		
2750 - 2626	8.5.0				8.5.1	8.5.1	8.5.1	8.5.1	8.5.1	8.5.1	8.5.1		
2625 - 2501	7.5.0				7.5.1	7.5.1	7.5.1	7.5.1	7.5.1	7.5.1	7.5.1		
2500 - 2376	6.4.0				6.4.1	6.4.1	6.4.1	6.4.1	6.4.1	6.4.1	6.4.1	6.4.1	6.4.1
2375 - 2251	5.4.0				5.4.1	5.4.1	5.4.1	5.4.1	5.4.1	5.4.1	5.4.1	5.4.1	5.4.1
2250 - 2126	4.1.0	4.3.0								4.3.1	4.3.1		
2125 - 2001	3.1.0	3.3.0								3.3.1			
2000 - 1876	2.1.0	2.2.0								2.2.1			
1875 - 1751	1.1.0	1.2.0								1.2.1			
→ Width	2000 - 2687		3501 - 3625	3626 - 3875	3876 - 4125	4126 - 4375	4376 - 4500	4501 - 4625	4626 - 4875	4876 - 5000	5001 - 5125	5126 - 5375	5376 - 5500

2 Bottom profile

Depending on the size, 4 versions of the bottom profile
0 mm, 9 mm, 17 mm, 32 mm are used.

Door height achieved by mixing panel heights (except ribbed variants). Use of bottom profiles, or top/bottom panel cut-downs.

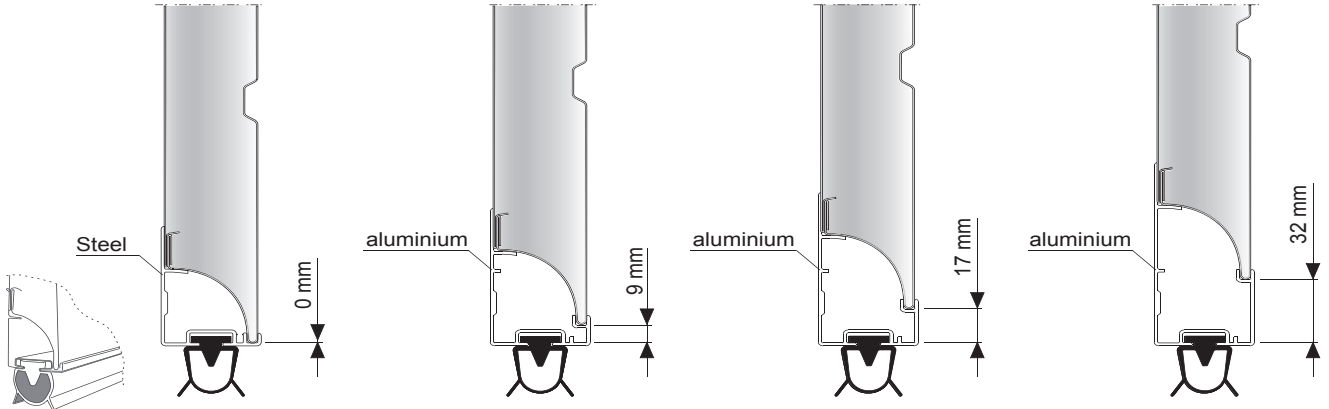

3 Headroom 120/240 mm

The required headroom increases by + 25 mm for doors with reinforced roller retainers and 4-fold spring ducts

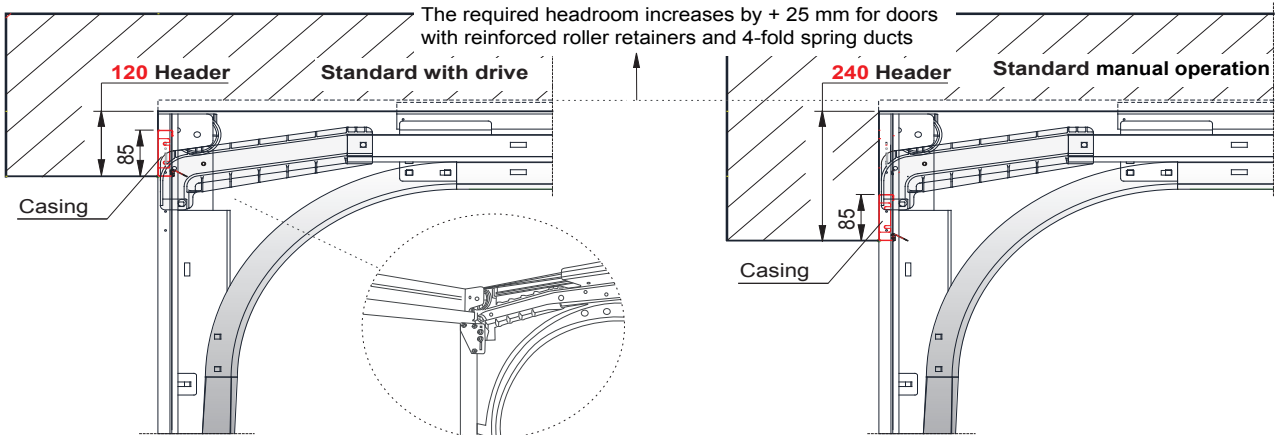

4 Slat trim / Header trim

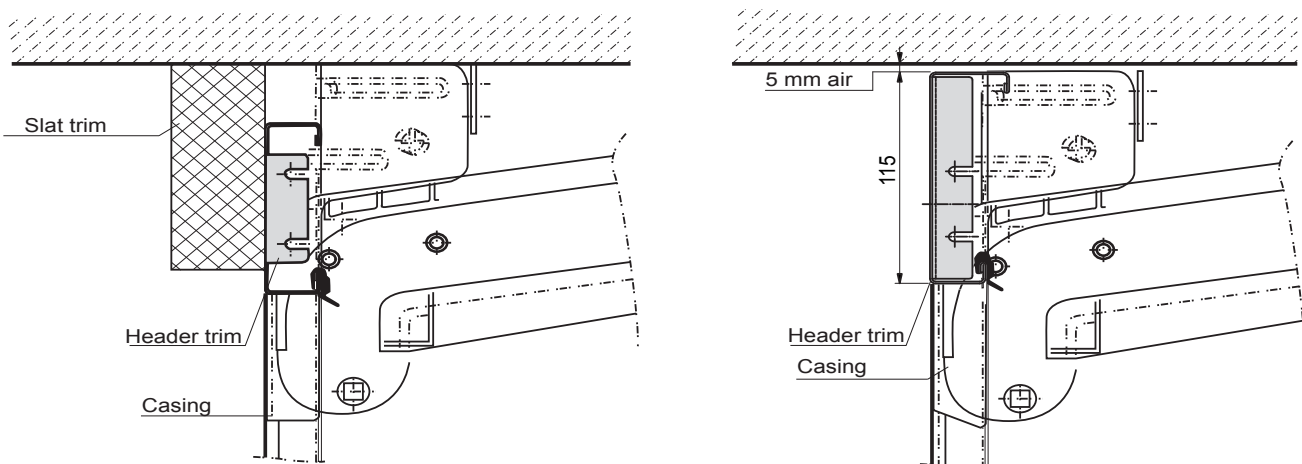



5 Buffer variants

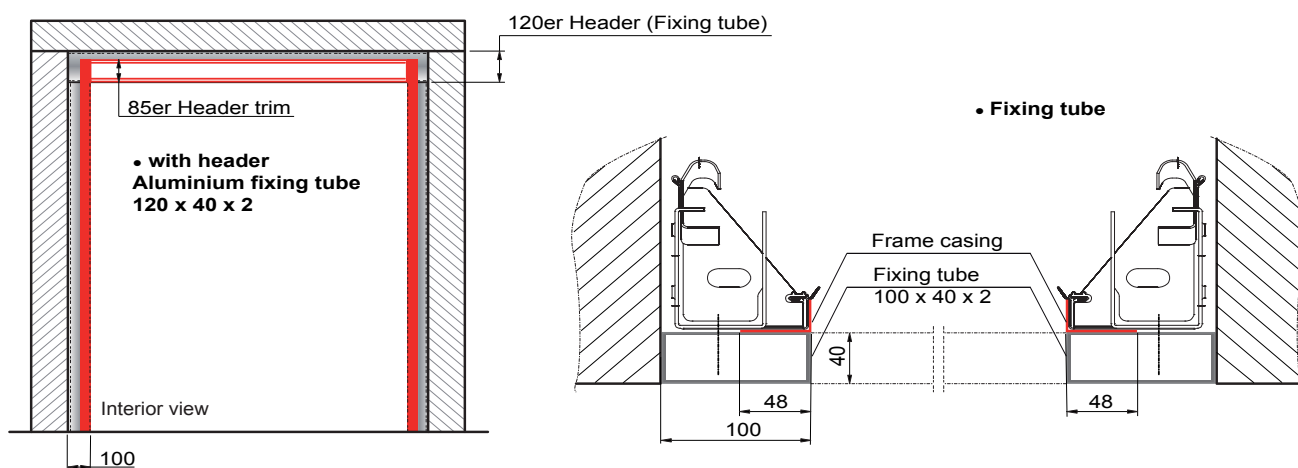
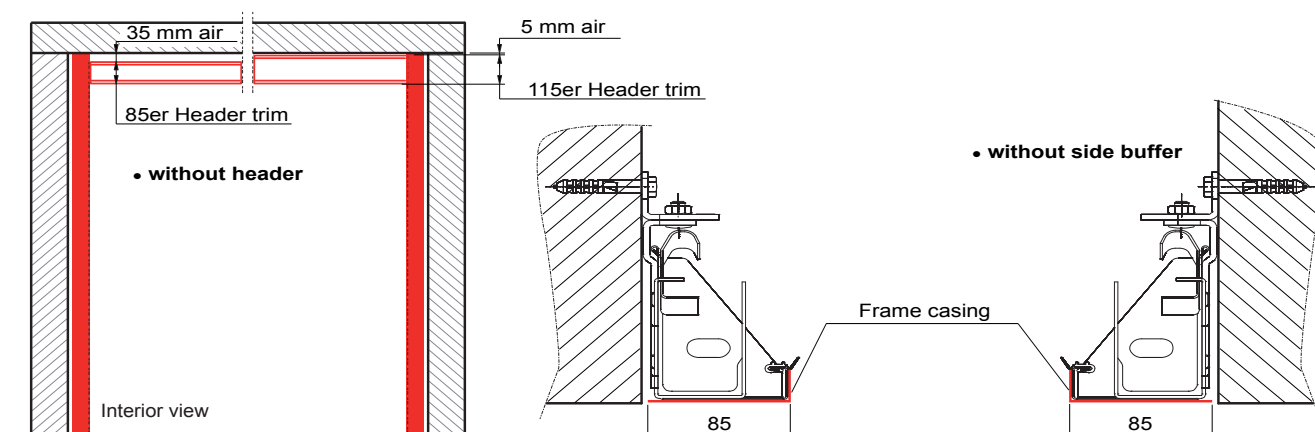
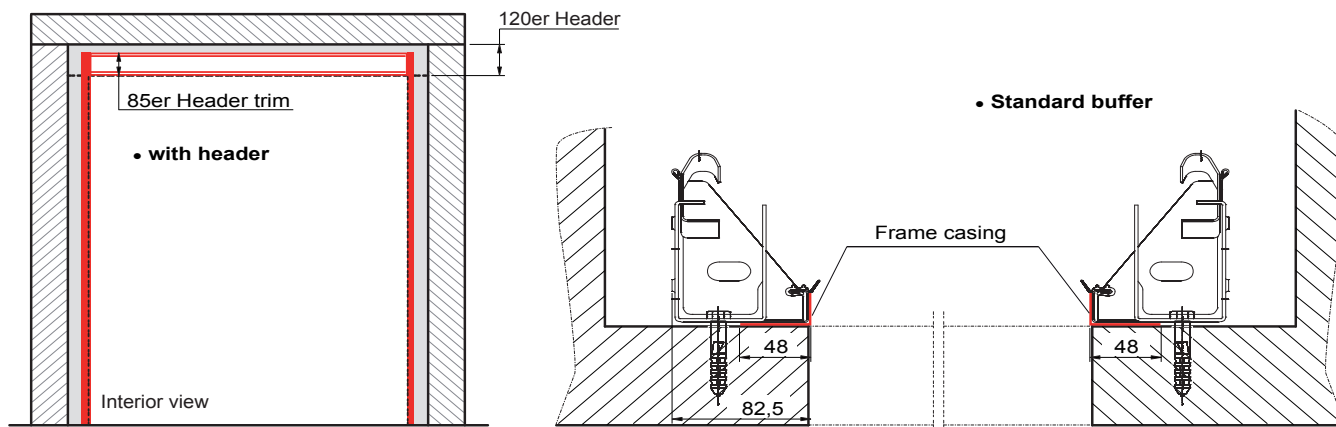

6 Door stopper

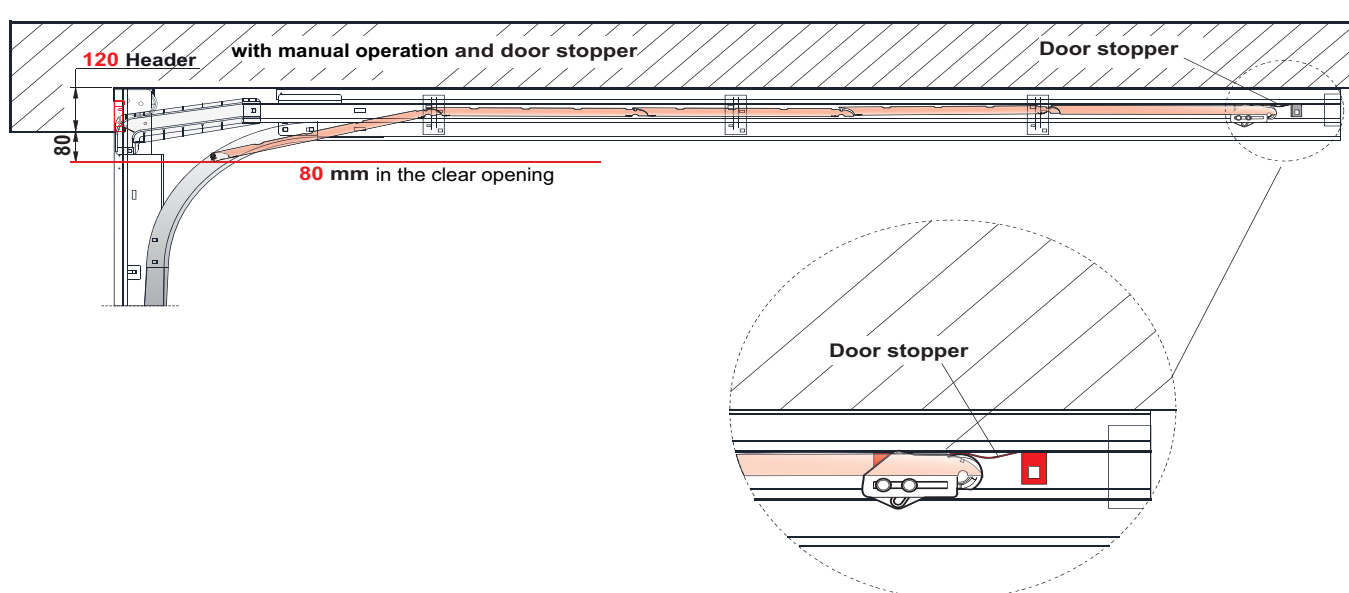
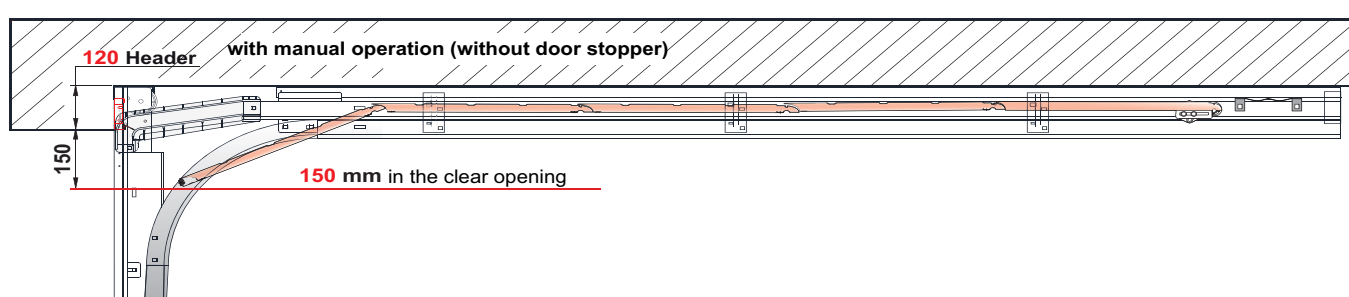

7 Covered corrosion protection / spacer

A special plastic element decouples the vertical frames from the floor. Whether after a rain shower or in the event of seeping dampness - the construction ensures that the foot section constantly receives air, dries quickly and is hence permanently protected from corrosion.

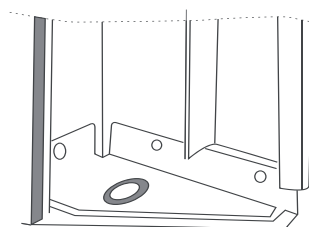
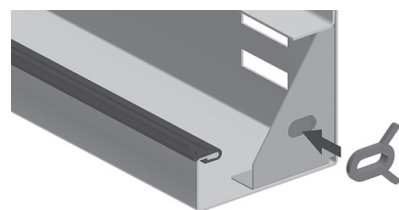



Dimension tables

Sectional door GSW 40 ribbed / centre ribbed and unribbed

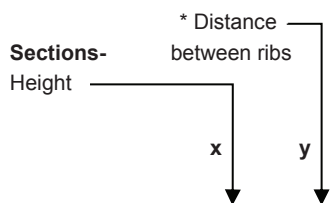

x	493	469	556	525
y	123	117	138	131

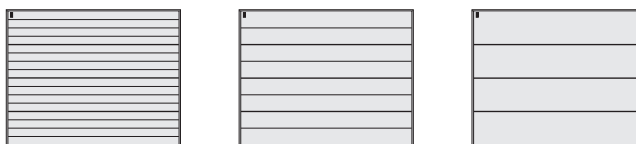

Type rectangular 1, crossbar, multiple mullion, rhombus-shaped

max. number of glazing elements per section

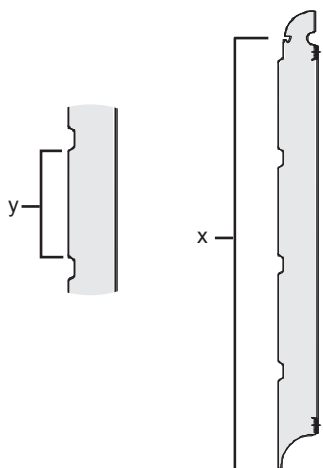
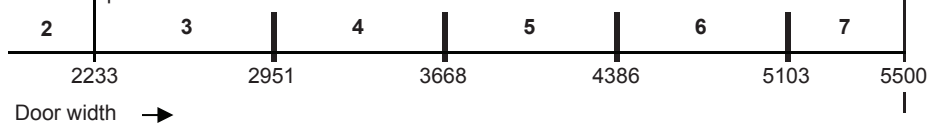

Type rectangular 2, max. number of glazing elements per section

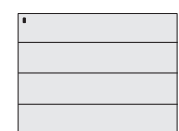
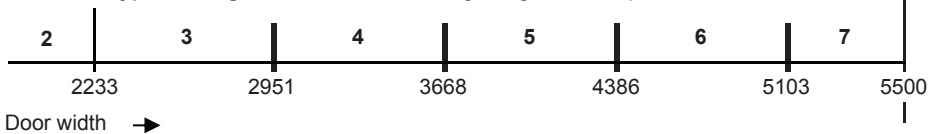

Type rectangular 3, max. number of glazing elements per section

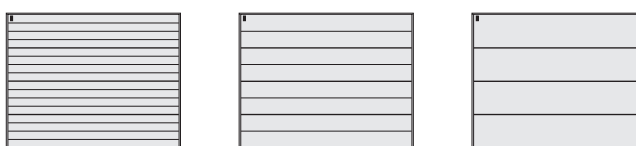
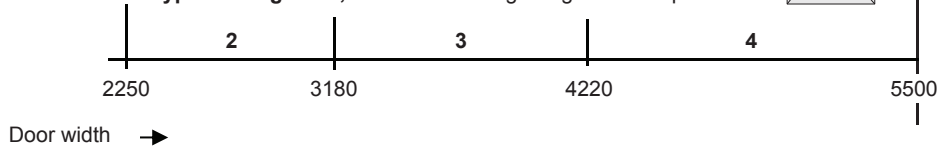

Type aluminium glazed strip, Number of aluminium strips

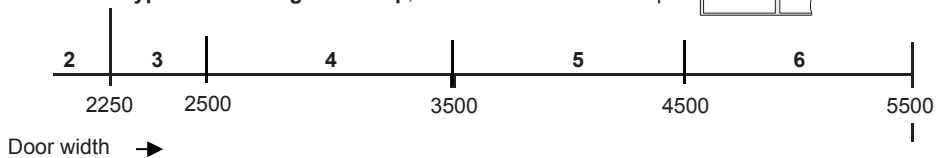

Sectional door GSW 40 with cassette

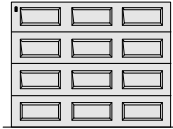

Type rectangular 1, crossbar, multiple mullion, rhombus-shaped

max. number of glazing elements per section

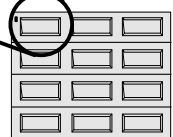
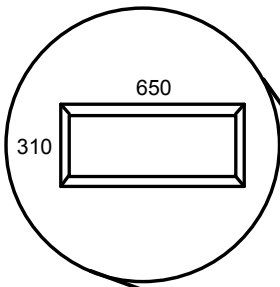
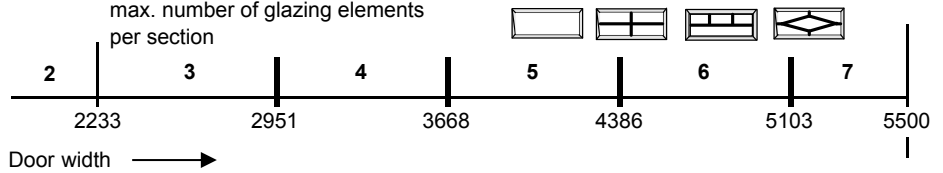

Type aluminium glazed strip, Number of aluminium strips

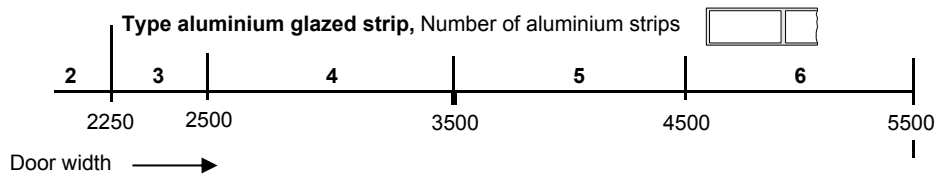

carTeck[®] Sectional Door

GSW 40-L - Supersize



Double-skinned steel slats 40 mm

Product description

Versions: The drawings represent a 2500 x 2125 mm garage door



Ribbed

evenly arranged horizontal ribs of the door leaf

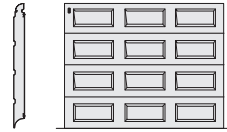

with cassette

evenly arranged panels across the whole width of the door

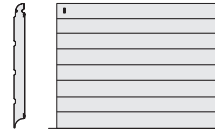

Centre Ribbed

evenly arranged horizontal ribs of the door leaf

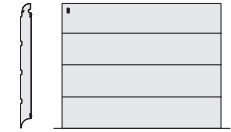

Unribbed



Tested burglar resistance:

All GSW 40-S, GSW 40-M and GSW 40-L CarTeck sectional doors with CarTeck drive satisfy the TÜV-tested TTZ guidelines "Burglar resistance for garage doors".

This applies to all doors with a locked door leaf (without glazing and without a wicket door)

5 Point Guarantee



5-year manufacturer's guarantee

on rollers, hinges, springs*, cable drums and cables under normal use of max. 5 openings/closings per day.

10-year manufacturer's guarantee

(see accessoires)

10-year manufacturer's guarantee

on the panel against rusting from the inside

10-year manufacturer's guarantee

on the steel splitting away from the foam

10-year manufacturer's guarantee

on the material and manufacturing faults of all immovable frame parts which are proven to be inoperative or seriously impaired on floor seal, central seals, side seals and header seal against perishing.

Please notify us immediately in writing if faults occur; the respective parts have to be sent to us on request.

Unfortunately, we shall not assume the costs for disassembly and assembly, freight or postage.

Standard version

• Garage sectional doors for domestic use

- With special connection console for rail-guided CarTeck drives

Door leaf GSW 40-S, GSW 40-M and GSW 40-L

- Door leaf consisting of individual, double-skinned door sections, including central seal with even arrangement, made of galvanized sheet steel 0.4 mm (GSW 40-S 0.3 mm panel outer surface)
- With finished surface, two layers on the outside (polyester-based 25 µm), one layer on the inside (polyester-based 10 µm)
- Building depth of the sections is 40 mm. Polyurethane foam core
- Finger pinch protection inside and outside in accordance with DIN EN 12604
- U-value: 0.56 W/m²k (slat 40 mm), 0.95 W/m²k (only door leaf), 1.48 W/m²k (complete door, door surface 10 m²)
- All CarTeck sectional doors are supplied with finished surface quality

Door leaf GSW 40-S

Surface inside: Stucco design

Standard colour inside: Galvanized with transparent protective film (similar to Sendzimir galvanized)

Surface outside: Woodgrain design

Standard colour outside: Finished surface traffic white, similar to RAL 9016

Door leaf GSW 40-M

Surface inside: Stucco design

Standard colour inside: Galvanized with transparent protective film (similar to Sendzimir galvanized)

Surface outside: Woodgrain design, stucco design

Standard colour outside: Finished surface traffic white, similar to RAL 9016

Door leaf GSW 40-L

Surface inside: Stucco design

Standard colour inside: Finished surface grey white, similar to RAL 9002

Surface outside: Woodgrain design, stucco design, smooth, micro-profiled

Standard colour outside: Finished surface traffic white, similar to RAL 9016



Product description

Avoid dark, as well metallic or micaceous iron ore colours or films for garage doors in direct sunlight.

Panels may expand, but will return to original shape as they cool.

CarTeck trend colours 2013 for GSW 40-M and GSW 40-L

CarTeck trend colours in coil coated design

Flame red	based on	RAL 3000	White aluminium	based on	RAL 9006
Moss green	based on	RAL 6005	Grey aluminium	based on	RAL 9007
Fir green	based on	RAL 6009			
Anthracite grey	based on	RAL 7016			
Light grey	based on	RAL 7035			
Quartz grey	based on	RAL 7039			
Window grey	based on	RAL 7040			
Sepia brown	based on	RAL 8014			
Cream	based on	RAL 9001			
Jet black	based on	RAL 9005			

trend colours with metallic effect
micaceous iron ore particles, not high gloss

Grey shades	TT 703 with micaceous iron ore particles
Brown shades	TT 8014 with micaceous iron ore particles
Anthracite shades	TT 9011 with micaceous iron ore particles

We reserve the right to change our trend colours from coil-coated design to painted design.

CarTeck wood designs 2013 for GSW 40-L

Film coating in UV resistant, thermoplastic surface film with wood design

- "Golden Oak"
 - "Rosewood"
 - "Dark Oak"
 - "Winchester"
- (Not Standard Rib)

CarTeck RAL of your choice for GSW 40-M, GSW 40-L

CarTeck Colour of the steel sections similar to RAL colour chart

Therefore, always contact the sales department for the following colours:

Black red	based on	RAL 3007
Black blue	based on	RAL 5004
Black grey	based on	RAL 7021
Black brown	based on	RAL 8022
Signal black	based on	RAL 9004
Jet black	based on	RAL 9005
Graphite black	based on	RAL 9011
Traffic black	based on	RAL 9017

The following RAL colours are not supplied:

Traffic purple	based on	RAL 4006
Purple violet	based on	RAL 4007
Matt black	based on	RAL 9021
Grey aluminium	based on	RAL 9007

This also applies to all pearl, fluorescent and metallic colours.

Frame GSW 40-S

- Profile frame made of Sendzimir galvanized sheet steel, coil-coated with polyester finish surface traffic white similar to RAL 9016
- Seal casing with lip seal, at the side and at the header trim in EPDM quality
- 85 mm header trim default in traffic white similar to RAL 9016

Frame GSW 40-M and GSW 40-L

- Profile frame made of Sendzimir galvanized sheet steel, coil-coated with polyester finish surface traffic white similar to RAL 9016
- Optionally frame panelling in trend and RAL colours or films in wood design too at an additional charge
- Seal casing with lip seal, at the side and at the header trim in EPDM quality
- 85 mm header trim default in trend and RAL colours or films in wood design

Counterweight

- Via multiple tension spring / double cable system enclosed in a micro-profiled spring duct above the horizontal runner rail

Special version

- Default without manual locking mechanism. On request with manual locking mechanism (up to door width of 5000 mm)

Please refer to the CarTeck drives section for headrooms, recoil depths and descriptions See page 13.

Ordering Sizes

Horizontal track lengths	3645			3170			3520			3045			3395			2870		
	13	13	13	13	13	13	13	13	13	13	13	13	13	13	13	13	13	13
Overall length CarTack motor	11 = 3286																	
Turning motor head through 90 degrees	200's -133mm																	
200's -133mm	300's -18mm																	
300's -18mm	Allow 115mm headroom. Use standard lifting gear.																	
Allow 140mm headroom above trays only.	Gear uses twin springing & Commercial roller spindles.																	
3000	13	13	13	13	13	13	13	13	13	13	13	13	13	13	13	13	13	13
2875	13	13	13	13	13	13	13	13	13	13	13	13	13	13	13	13	13	13
2750	13	13	13	13	13	13	13	13	13	13	13	13	13	13	13	13	13	13
2625	13	13	13	13	13	13	13	13	13	13	13	13	13	13	13	13	13	13
2500	12	12	12	12	12	12	12	12	12	12	12	12	12	12	12	12	12	12
2375	12	12	12	12	12	12	12	12	12	12	12	12	12	12	12	12	12	12
2250	12	12	12	12	12	12	12	12	12	12	12	12	12	12	12	12	12	12
2175	11	11	11	11	11	11	11	11	11	11	11	11	11	11	11	11	11	11
2125	11	11	11	11	11	11	11	11	11	11	11	11	11	11	11	11	11	11
2050	11	11	11	11	11	11	11	11	11	11	11	11	11	11	11	11	11	11
2000	11	11	11	11	11	11	11	11	11	11	11	11	11	11	11	11	11	11
1925	11	11	11	11	11	11	11	11	11	11	11	11	11	11	11	11	11	11
1875	11	11	11	11	11	11	11	11	11	11	11	11	11	11	11	11	11	11
260 / 360																		
2000	2250	2375	2500	2625	2750	3000	3250	3500	3750	4000	4250	4500	4750	5000	5250	5500	5800	
270 / 370																		
280 / 380																		

Width in mm

Installation Dimensions Super Size Doors

N - Normal fitting Doors over 5500mm wide have bracings to the rear of the door panels

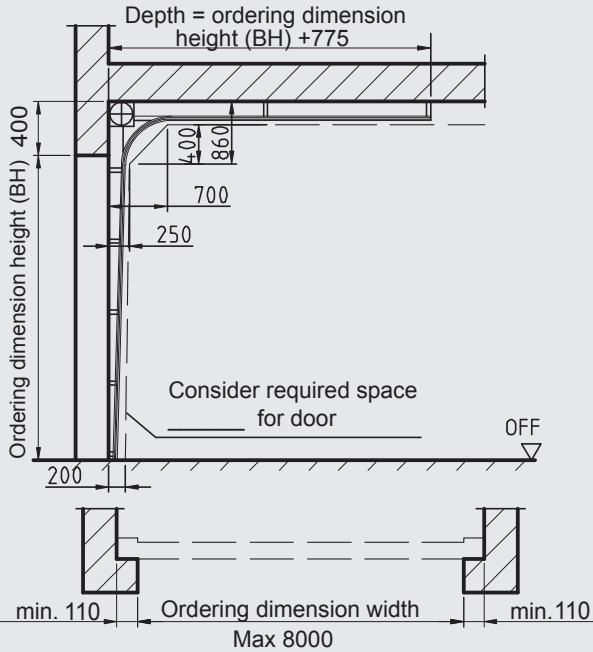

NB Installation must be carried out by:
 1) Competent person
 2) Electrical programmer/installer

Type	Direct mo. drive
N/ND	110/220

N= side room without motor
 ND= side room where motor controlled

NSH - Low headroom fitting Doors over 5500mm wide have bracings to the rear of the door panels

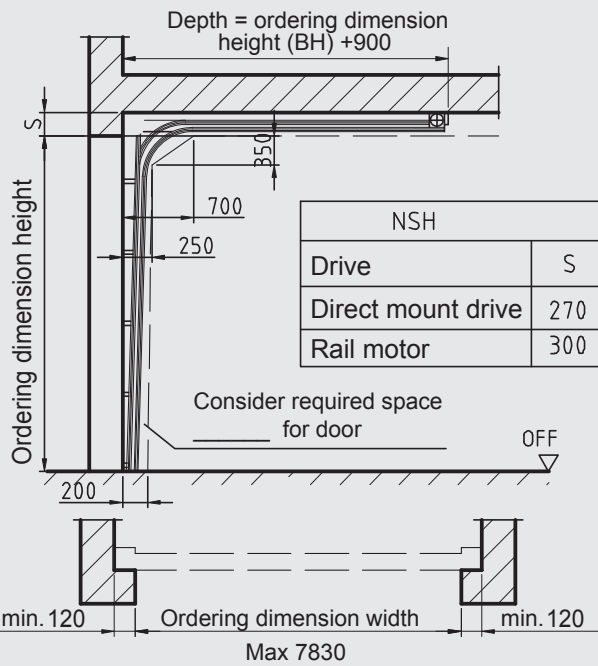

NSH	
Drive	S
Direct mount drive	270
Rail motor	300

Type	Direct mo. drive
N/ND	110/220

N= side room without motor
 ND= side room where motor controlled

Doors have galvanised frame legs and are supplied without a header strip

Installation Dimensions Side Hinged Doors

The section height and the height of the handle 'x' depend on the actual door height and construction of the door.



Installation behind the soffit, only inward opening

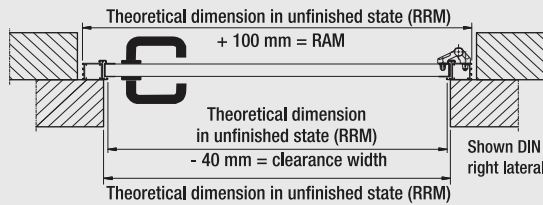

Installation within the soffit, inward or outward opening

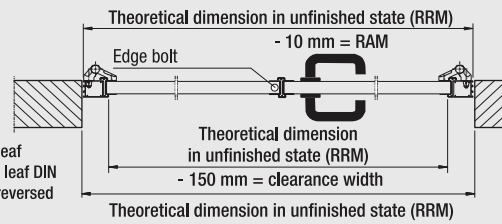
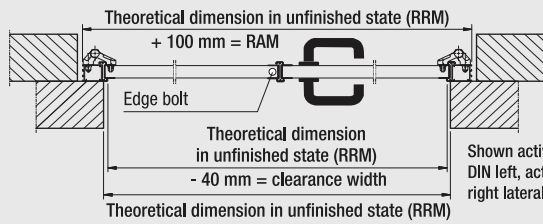
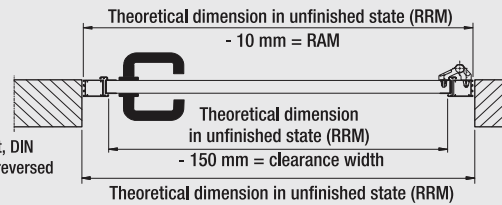

Installation behind the soffit, only inward opening

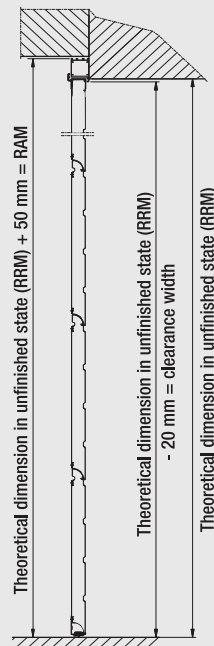

Caution: Frame outer dimension (RAM) = order size

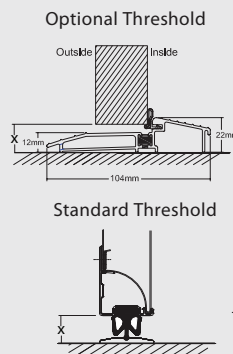

Installation within the soffit, inward or outward opening

